

## TUBO, ADAPTADORES E CONEXÕES

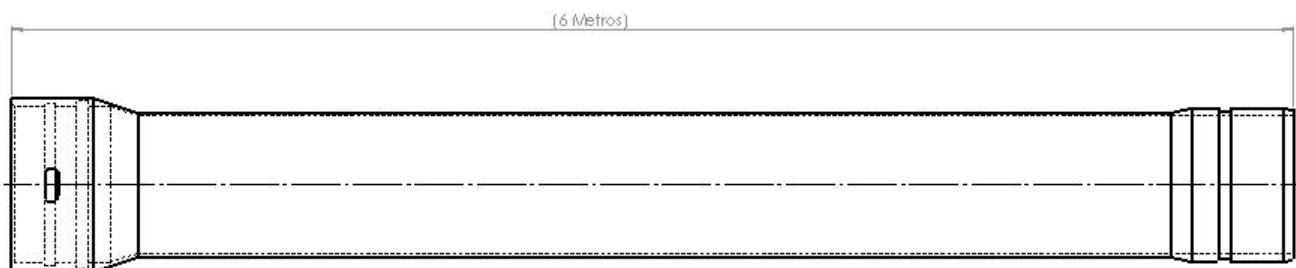

Dados técnicos

Diâmetro: 6", 8" e 10".

Classe de pressão: 16Kgf/cm<sup>2</sup> (160mca).

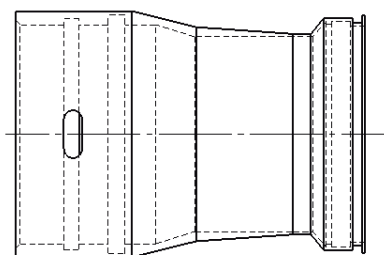

Adaptador BFiBAI

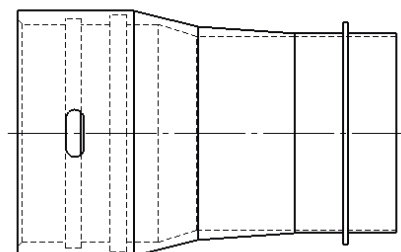

Adaptador BFiPAI

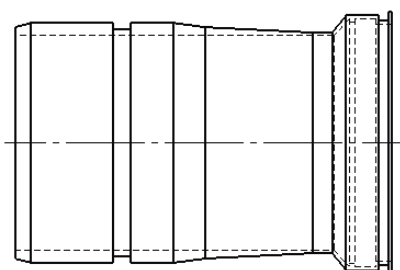

Adaptador PFiBAI

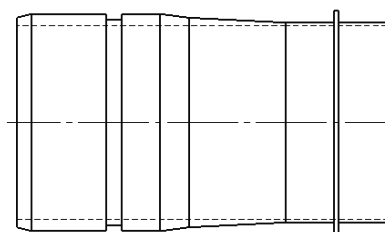

Adaptador PFiPAI

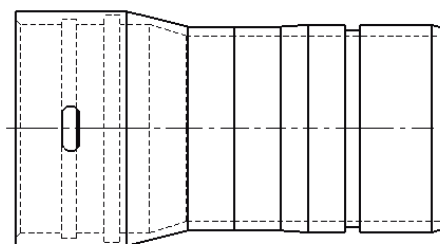

Adaptador PB



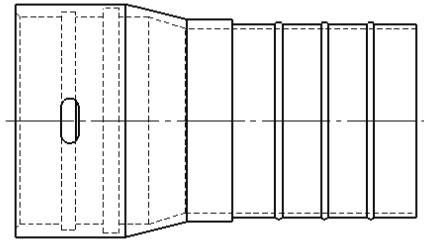

Bolsa para mangueira

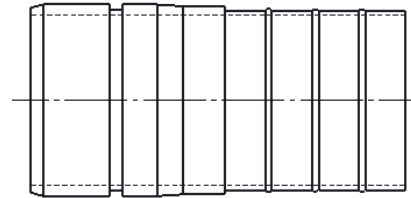

Ponta para mangueira

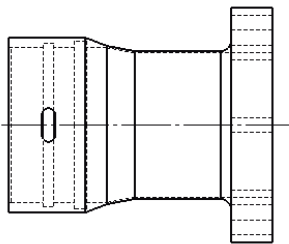

Extremidade BF

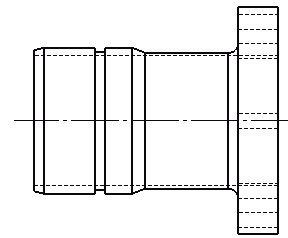

Extremidade PF

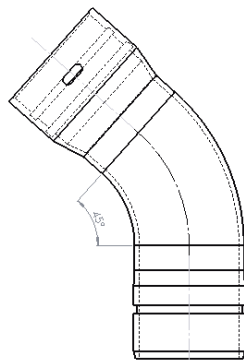

Curva 45° PBAT

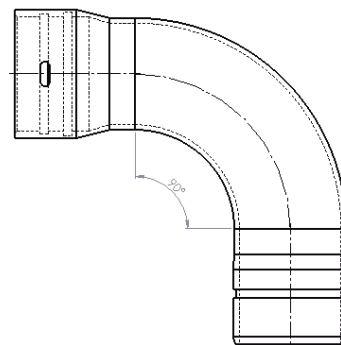

Curva 90° PBAT

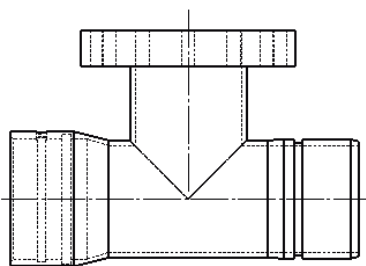

TE BPF

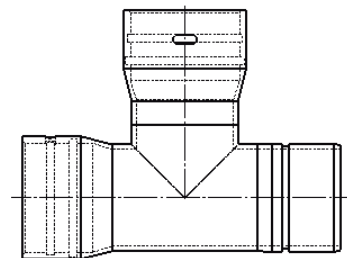

TE BBP

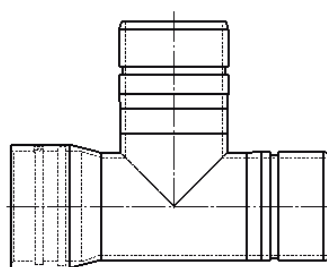

TE BPP